

United States
Department of
Agriculture

Forest Service

Forest
Products
Laboratory

Research
Paper
FPL-RP-537



Conditioning Stress Development and Factors That Influence the Prong Test

James Fuller

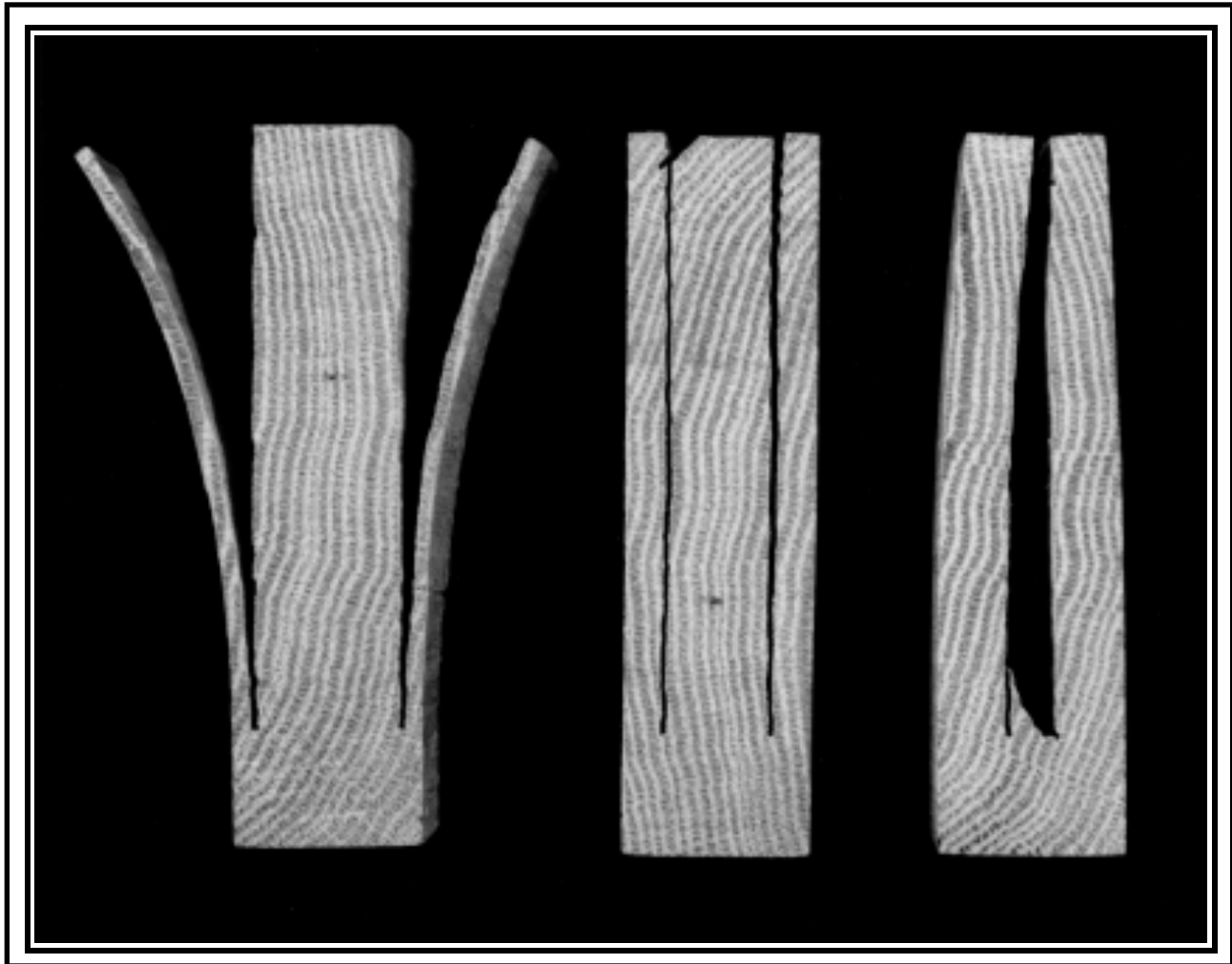

Abstract

To relieve transverse drying stresses, lumber must be conditioned. The standard prong test has been used for many decades to determine the duration of conditioning time. However, little work has been directed at the proper procedures or interpretation of the prong test. The purpose of this study was to gain additional information about stress development during conditioning and moisture changes influencing prong response. Data on stress distribution, moisture gradient, and prong response were obtained periodically throughout conditioning. A residual strain release method, slicing, was used to obtain stress distributions. Results demonstrate that the prong response is a function of prong thickness and stress distribution. The time-dependent moisture gradient was shown to influence the final strain pattern. Further studies concerning conditioning schedules need to be completed before a desired prong response can be determined.

Acknowledgment

This research was conducted at the North Carolina State University, Wood and Paper Science Department, Raleigh, North Carolina.

April 1995

Fuller, James. 1995. Conditioning stress development and factors that influence the prong test. Res. Pap. FPL–RP–537. Madison, WI: U.S. Department of Agriculture, Forest Service, Forest Products Laboratory. 6 p.

A limited number of free copies of this publication are available to the public from the Forest Products Laboratory, One Gifford Pinchot Drive, Madison, WI 53705–2398. Laboratory publications are sent to more than 1,000 libraries in the United States and elsewhere.

The Forest Products Laboratory is maintained in cooperation with the University of Wisconsin.

The United States Department of Agriculture (USDA) Forest Service is a diverse organization committed to equal opportunity in employment and program delivery. USDA prohibits discrimination on the basis of race, color, national origin, sex, religion, age, disability, political affiliation, and familial status. Persons believing they have been discriminated against should contact the Secretary, U.S. Department of Agriculture, Washington, DC 20250, or call (202) 720–7327 (voice), or (202) 720–1127 (TTY).

Conditioning Stress Development and Factors That Influence the Prong Test

James Fuller, Research Scientist
Forest Products Laboratory, Madison, Wisconsin

Introduction

To avoid excessive shrinkage while in service, wood must be dried prior to remanufacturing. During drying, internal stresses develop in lumber as a result of unavoidable moisture gradients that set up differential shrinkage patterns throughout the thickness of the lumber (McMillen 1963, Youngs 1957). At the end of drying, lumber is casehardened, which is the state in which the surface of the lumber is stressed in compression and the center in tension. When lumber is in this state and resawn or unequally surfaced, the final shape can be distorted. To minimize or eliminate casehardening, the lumber is conditioned to relieve these stresses.

Most research conducted to examine stress development has focused on stresses during drying and after conditioning. Reasons for this are the short time involved in conditioning compared with drying and the extreme danger of collecting samples in a kiln containing steam. Knowledge of how drying stresses are altered during conditioning is important in developing adequate conditioning schedules. In addition, knowledge of stress development during conditioning would enable development of meaningful quality control tests.

The prong test is used by industry as part of its quality control program to assess the degree of casehardening in lumber. Currently, commercial kiln operators are advised to follow procedures set forth in kiln manuals, which includes using a prong test. The prong test indicates only whether a stress gradient of a form that causes prong deformation exists, not the stresses within the whole board. A survey of kiln manuals, which recommend different standard prong geometries and response, indicates considerable disagreement among recommendations (Table 1). Standard prong test procedures ignore the interactions that prong length and thickness have with prong response. Some manuals ignore that the immediate increase or decrease in the surface layer moisture content (MC) can possibly yield false results (Churchill 1954, McMillen 1963). To consider this issue, authors of some kiln manuals (Table 1) and instructors of short courses often advise operators to reevaluate the prong test after a short period to eliminate any bias in interpretation created by

Table 1—Suggested prong geometry and response by various authors

Reference	Board thickness (in.)	Prong		Prong response
		Number	Thickness ^a	
Bramhill and Wellwood 1976	2	6	— ^b	—
Cech and Pfaff 1977				
Situation 1	1	2	50%	All prongs are to be of equal length
Situation 2	—	2–5	—	
Cech and Pfaff 1979	1	6	—	Slight outward bow
Page 1973	1-1/2	2	0.25 in.	--
Simpson 1991	<1-1/2	2	—	Straight prongs
Wengert 1990				
Situation 1	<1-1/2	2	24%	—
Situation 2	>1-1/2	>2		Bow outward by 0.25 in.

^aPercentage or inches of board thickness; 1 in. = 25.4 mm.

^b—, not stipulated in manual.

moisture gradients present when the test was originally interpreted.

Although the prong test has been used for decades to determine the degree of stress relief, there is no standard way to report the results. Churchill (1954) quantitatively recorded casehardening as the post-cut surface and center slice length difference divided by the nonconditioned, uncut board width. This value is based on two different measurement times and does not include possibilities of a complex stress gradient.

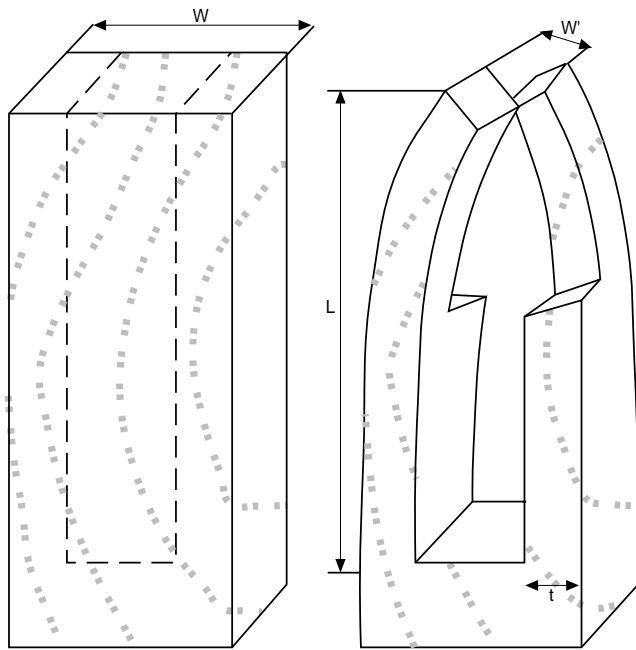

Figure 1—Prong test geometry and recorded measurements: W = precut prong tip distance; W' = released prong tip distance; L = prong length; t = prong thickness.

Therefore, the value is false and cannot be interpreted. Cup (Nishio 1976, 1977a, 1977b) and slit width (Moren 1994) are inappropriate reporting methods that use an equation depicting a linear relationship of prong half-length deflection. This method does not take into consideration board width and complex stress gradients.

An equation recently developed by Fuller (1993) and Fuller and Hart (1994) was selected to provide an indication of an existing stress gradient as displayed by the prong test and the true geometry of the prong response. The equation takes into account that when the prongs are released, they do not merely shift in or out nor do they bend at the connecting base. The prongs bow through the entire length following the curve of a circle that is described by a second degree polynomial. Therefore, the prong response is a function of the prong length squared:

$$PR = (W - W')/L^2 \quad (1)$$

where PR is the degree of casehardening as displayed by the prongs; W is the precut prong tip distance; W' is the released prong tip distance; and L is the prong length (Fig. 1).

Prong test results are recorded such that when the prongs bow inward, displaying casehardening, results are positive. When the prongs bow outward, displaying reverse casehardening,

Table 2—Kiln conditions used in the modified drying schedule

Moisture content (%) or step	T2-C1 modified (°F) ^a		Equilibrium moisture content (%)
	Dry-bulb	Wet-bulb	
>40	95	92	19.0
40-35	95	91	17.4
35-30	100	94	15.0
30-25	110	100	12.0
25-20	120	95	6.6
20-15	130	90	3.8
15-11	150	110	4.2
<11	160	120	4.3
Conditioning	160	149	11.0

$$^{\circ}\text{C} = (^{\circ}\text{F} - 32)/1.8.$$

results are negative. The prong test response is recorded in inches⁻¹ (millimeters⁻¹).

Thickness of the prong needs to be addressed when interpreting the prong test. However, before a desired prong response can be selected, the desired corresponding stress profile needs to be determined.

The objective of the study reported here was to gain additional information about stress development during conditioning and moisture changes influencing prong response. This would supply some of the needed data for the development of precise procedures for kiln operators when monitoring the charge being conditioned, thereby obtaining stress-free lumber.

Methods and Materials

For this study, 1-1/2-in. (38-mm) airdried red oak boards were obtained. Prior to drying, all except four boards were planed to 1-1/4 in. (32 mm). These four boards were used to obtain material data for transverse modulus of elasticity (MOE) and specific gravity. After planing both sides evenly, MC of the boards was 34 percent. Planing was included to reduce both the presence of surface checks and the subsequent drying time. Planing also removed the shell containing any tension set. Three of the clearest boards greater than 5 in. (127 mm) wide were selected. These boards were ripped on a straight-line-rip saw to 5 in. (127 mm).

A T2-C1 modified drying schedule was used (Table 2). This schedule is commonly used in the geographic region where this research was done because of the occurrence of wet wood infection in red oak. Airflow was reversed every 6 h. Two

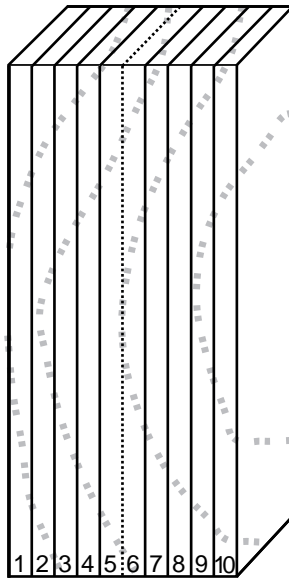

Figure 2—Slice test with the slices numbered.

columns of boards were stacked such that one pile contained the kiln sample boards used to monitor the MC during drying and the other pile contained the three test sample boards. The first set of slice and prong samples was taken just before conditioning was initiated, and subsequent samples were taken at the following hours into conditioning: 1, 2, 4, 6, 14, 22, and 35. At each sampling, a 12-in. (300-mm) block was taken from each of the three test boards to provide eight prong and two slice samples. The ends of the board were sealed immediately with neoprene coating after each block was cut.

Lumber is usually not remanufactured immediately after conditioning. This delay causes reduction in the moisture gradient. To represent lumber in normal use, half the material from each block after being pulled for the kiln was wrapped in plastic for 2 days before being processed. This allowed the moisture gradient to be reduced and the block to cool. Both the wrapped material and the immediately processed material were processed identically. Throughout this report, this material is denoted as wrapped samples and immediately processed samples.

Slice Test

The slice test (Fig. 2) was used to obtain both the moisture and strain gradients. These data were used to determine the level of stress. As each sample was processed, its width was measured. On the end grain, slices 1 to 4 were marked on the pith side and slices 7 to 10 on the bark side. A slice, including the bandsaw kerf, one-tenth of the board thickness, was then sawn from both surfaces. The slices were immediately weighed individually and measured to the nearest 0.001 in. (0.025 mm). This procedure was repeated until the center

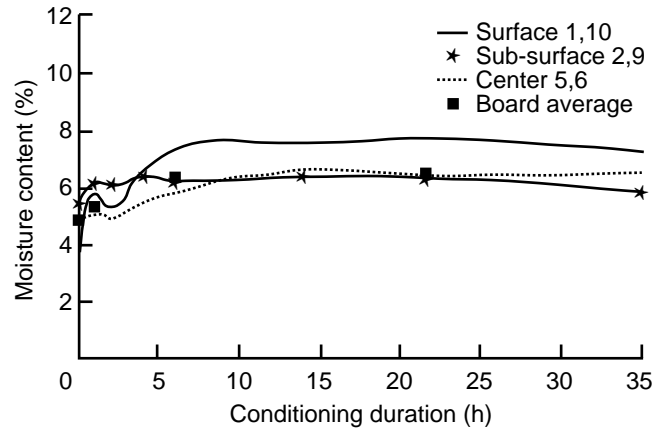

Figure 3—Average moisture content within three layers across the board thickness for the immediately processed samples from three 1-1/4-in. (32-mm) red oak boards during conditioning.

two-tenths of the board thickness remained. This process was completed within 15 min from when the sample was taken from the kiln. All slices were oven-dried for 24 h and then reweighed. The approximate average board MC was determined by adding the weights of all slices before inserting the weight values into the MC equation.

Prong Test

Figure 1 depicts prong geometry and recorded measurements. Four prong tests were performed on each board at each sampling time such that influence of prong thickness could be monitored. The four prong thicknesses were 10, 20, 35, and 50 percent of the board thickness. Prong response was recorded simultaneously with strain and MC data.

Results and Discussion

Moisture Content Gradient

As a result of scheduling conflicts, the step prior to conditioning in the drying schedule was prolonged an extra day, which helped flatten the moisture gradient. The set points for conditioning, dry-bulb 160°F (71°C), wet-bulb 149°F (65°C), and equilibrium moisture content (EMC) 11 percent, were achieved more rapidly than sometimes can be achieved in commercial kilns, which are large and sometimes cause the dry-bulb temperature to overshoot the desired set point. This is called kiln-overheat. The MCs of the slices are shown in Figure 3. (For clarity, only three layers are shown.) The other two layers, intermediate 3,8 and hyper-center 4,7 are situated between subsurface 2,9 and the center 5,6 shifted close to the center. Throughout this report, this pattern can

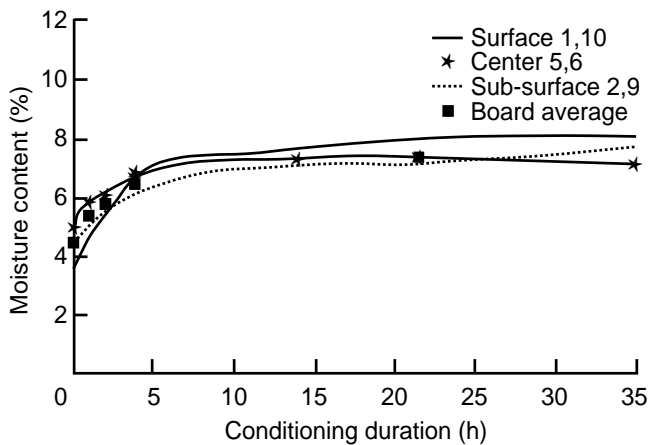

Figure 4—Average moisture content within three layers across the board thickness for the wrapped samples from three 1-1/4-in. (32-mm) red oak boards during conditioning.

be assumed when only three curves are shown for MC and stress levels. Most moisture gained was within the first 5 h of conditioning. Figure 3 shows at least a 1.5-percent MC difference between the surface and the other slices after 6 h, with little change in the total MC. In this run, monitoring of the kiln samples was not continued into conditioning. In the second run, this moisture gain pattern was repeated in the slices but at a slower rate for a different conditioning schedule. The peak occurred after about 20 h. However, the kiln samples in the second run showed a continued increase for 25 h up to 7.9-percent MC. This is explained by the loss of moisture while cutting the slices and a different stress profile between the two runs.

After the second hour, the decrease in MC resulted from kiln controls not being turned on immediately after removal of one sample, thereby reducing the EMC for about 30 min.

Figure 4 shows the average MC of each layer for the wrapped samples. Compared to Figure 3, Figure 4 shows a flatter gradient. The wrapped samples also showed a slightly increased average MC. Because samples were wrapped, they should not have gained moisture. The apparent gain in moisture was probably due to a greater moisture loss during slicing in the immediately processed samples, because these were warmer than the wrapped samples during processing.

Figure 4 shows a surface MC of 8.5 percent, with the EMC during conditioning at 11 percent. Only a small portion of this discrepancy was from moisture loss during cutting and weighing. The MC was low and the temperatures of the air and sample were close; therefore, little moisture was lost in this manner. The discrepancy was from hysteresis. The EMC curve is desorption, which occurs during conditioning. A hysteresis factor of 0.75, a plausible value, would be required to account for this difference. This indicates that both surface

MC and strain for the immediately processed samples can be corrected to a fairly accurate degree.

Transverse Stresses

Stresses are used to maintain static equilibrium for calculation purposes. However, it is the released strains that are measured, assumed to result completely from mechano-sorptive deformation, and the source of the stresses. Figures 5 to 7 show the strains that do not necessarily sum to zero. In a report by Fuller (Prong Test Prediction for Red Oak, in preparation), stresses used to successfully predict prong response were calculated from the recorded strains in the slice test and the MOE–MC curves obtained from the preliminary test.

Immediate strain magnitudes as a function of conditioning duration are shown in Figure 5. Initially, all three boards showed high levels of compression strain in the surface layers (slices 1, 10), nearly zero strain in the subsurface layers (slices 2, 9), and moderate levels of tension strain in the center layers (slices 5, 6). Within 6 h, strain in the surface layers decreased to about zero, while strain in the subsurface layers increased to high levels of compression. This reversal of the stress gradient means that a prong that included only these two layers would turn outward rather than inward. The strain values changed little after 15 h into conditioning, indicating that prolonged conditioning does not cause reverse casehardening.

Figure 6 shows the strain gradient across board thickness at different times for one board. For clarity, only time intervals of major developments are shown. Strain values were asymmetric. The maximum compression strain in the surface occurred at different times but at about the same magnitude within the same board. This was partially due to the growth geometry of the tree and was noted by Moren (1994). As a result, Figure 5 shows a lower average maximum strain than the actual maximum strain and a quicker reversal in the surface strains. However, Figure 5 does show the true general pattern of the strain history.

Two factors need to be considered in interpreting and understanding strain history: mechano-sorptive response and moisture migration. The sum of these influencing factors produces the altered strain profiles. Mechano-sorptive relaxation occurs with reversed stress and a change in MC. The reversed stress must increase to at least a critical level (Fuller 1993, Moren 1994). This level must be present during conditioning and achieved either during drying of the wood or when wood absorbs moisture during conditioning. Relaxation, which starts at the surface during conditioning, relieves high compression strain. Figure 5 shows a transition of the surface compression stress to tension and is explained as follows. When the surface stresses were relieved by the sudden increase in MC,

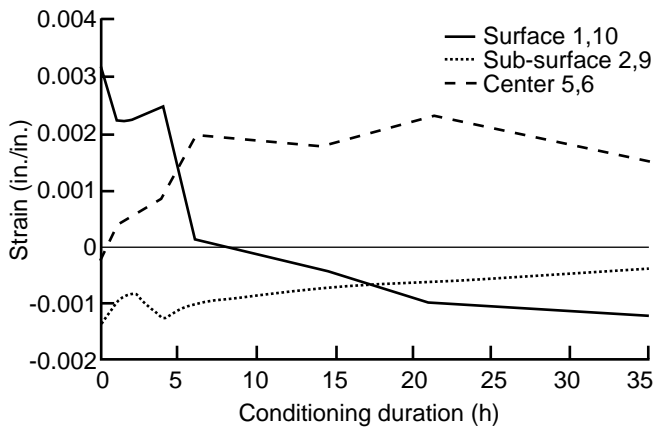

Figure 5—Immediately processed sample strain magnitude within three layers cross the thickness of the board during conditioning (1 in. = 25.4 mm).

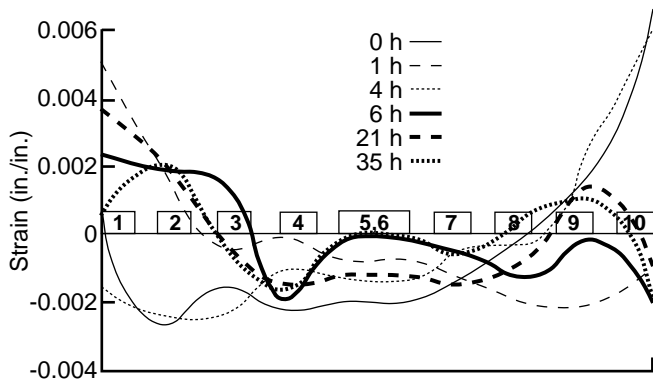

Figure 6—Strain profile across the thickness of the 1-1/4-in. (32-mm) red oak boards during conditioning with the sampling time and numbered slices (1 in. = 25.4 mm).

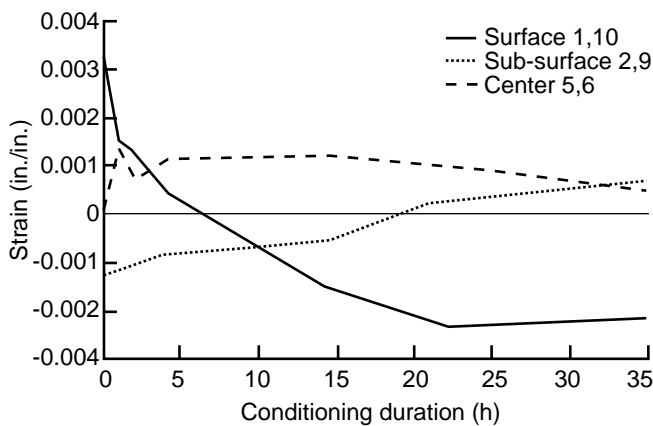

Figure 7—Wrapped sample strain magnitude within three layers across the thickness of the board during conditioning (1 in. = 25.4 mm).

two things occurred. One, the moisture migrated to the next inner layer (where the strain was near zero), causing it to swell. Two, the remaining layers contained mechano-sorptive strain. To maintain static equilibrium, the neutral stress axis must shift. Together, this puts the surface in tension. Checks may or may not open, depending on depth of the tension zone and degree of tension. In this study, only a small number of open surface checks were present after conditioning.

The strain resulting from the reduction of the moisture gradient by wrapping the board for 2 days is shown in Figure 7. Strain differences can be seen when comparing the immediately processed with wrapped samples. As expected, the surface moisture migrated to the inner slices. With the migration of moisture from the surface to the center, the strain gradually changed. The initial strain magnitudes in the surface were more negative (tension) in the wrapped samples than the immediately processed samples.

Prong Test

The immediately processed prong test samples were remeasured after a 45-min delay. These results consistently showed the same general pattern and similar magnitudes as the immediate results, with the 10-percent prong test results displaying the greatest dissimilarity. Only the 10-percent delayed prong results are shown in Figure 8. Even though the 10-percent prong results showed the greatest difference, they were not of such a magnitude that a kiln operator would be misled in decisionmaking.

The average prong response for the wrapped samples, used to simulate lumber in actual use, is shown in Figure 9. For the short conditioning times, the wrapped sample response was approximately the same as the immediately processed response. However, for the lengthier conditioning times, the values were markedly less. This is important to remember when interpreting the prong test results that are processed immediately after conditioning.

Conclusions

Strain data were obtained by slicing the board and did not indicate that prolonged conditioning causes reverse casehardening. In this study, stresses were not completely eliminated. With the gain of moisture during conditioning, surface stresses were found to attain a maximum value and then subside to near zero. This was accomplished through mechano-sorptive recovery. With a reduction in the moisture gradient after a 48-h delay before processing, the general patterns remained about the same except for a reduced magnitude of stress and a transition from tension to compression in the center or core of the board.

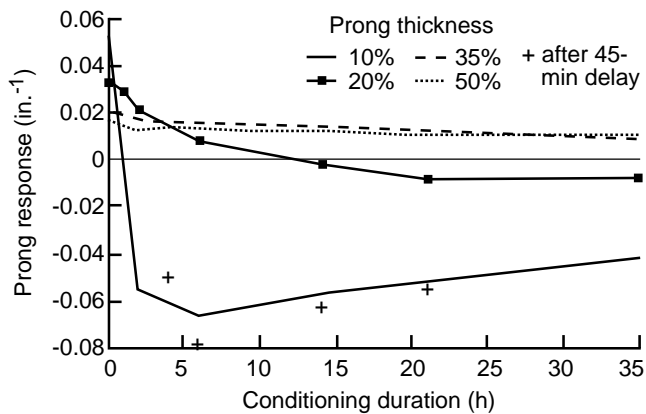

Figure 8—Average prong test immediate responses (1 in. = 25.4 mm).

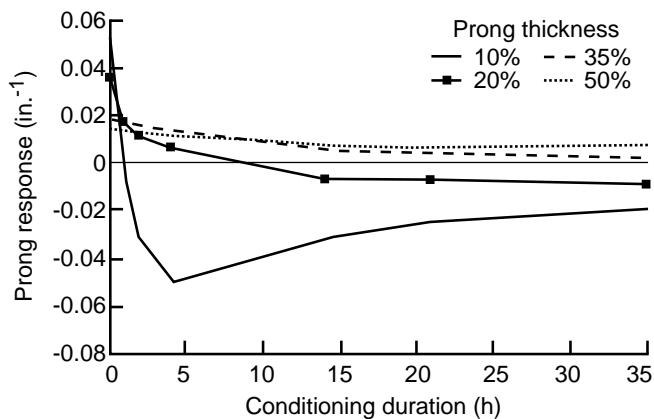

Figure 9—Average prong test wrapped response (1 in. = 25.4 mm).

The overall objective of this study was to gain additional information about stress development during conditioning and moisture changes influencing prong response. This study supplies some of the needed data to develop precise procedures for kiln operators when monitoring the charge being conditioned, thereby obtaining stress-free lumber.

Further research is needed on the influence of different kiln schedules, board thickness, and species before an overall conclusion can be made concerning standard prong test procedures. Although results of this study do not suggest a standard prong thickness, kiln operators are advised to maintain a constant prong thickness from one charge to the next for consistent results. Also, operators should be suspicious of prong tests that display reverse casehardening and should not take seriously sharp changes in prong response early in the conditioning process. The wood probably would still be casehardened early in the conditioning process, even if the prong test indicates otherwise, unless the EMC in the kiln was extremely high.

References

- Bramhill, G.; Wellwood, R.** 1976. Kiln drying of western Canadian lumber. Inf. Rep.. VP-X-159. Vancouver, British Columbia: Canadian Forestry Service. Western Forest Products Laboratory.
- Cech, M.; Pfaff, F.** 1977. Kiln operator's manual for eastern Canada. Rep. OPX192E. Ottawa, Ontario: Eastern Forest Products Laboratory.
- Cech, M.; Pfaff, F.** 1979. A quick guide for the dry kiln operator. Rep. OPX217E. Ottawa, Ontario: Eastern Forest Products Laboratory.
- Churchill, J.** 1954. The effect of time, temperature and relative humidity on the relief of casehardening stresses. *Forest Products Journal*. 4(5): 264-282.
- Fuller, J.** 1993. Lumber drying stress development and prong test implications. Thesis. Raleigh, NC: North Carolina State University.
- Fuller, J.; Hart, C.** 1994. Factors that influence the prong test. In: Proceedings, 4th international IUFRO drying conference; 1994 August 9-13; New Zealand.
- McMillen, J.** 1963. Stresses in wood during drying. Res. Rep. 1652. Madison, WI: U.S. Department of Agriculture, Forest Service, Forest Products Laboratory.
- Moren, T.** 1994. Steam conditioning after low temperature drying. *Holz als Roh- und Werkstoff*. 52: 77-82.
- Nishio, S.** 1976. Estimating drying stress in wood by cup Method II comparison of cup method with slice method. *Journal of Japan Wood Research Society*. 22(11): 626-631.
- Nishio, S.** 1977a. Estimating drying stress in wood by cup Method III variation of the cup quantity under different drying conditions and with different conditions of thickness of boards. *Journal of Japan Wood Research Society*. 23(4): 180-186.
- Nishio, S.** 1977b. Estimating drying stress in wood by cup Method IV drying stresses in Tanoak. *Journal of Japan Wood Research Society*. 23(4): 180-186.
- Page, R.** 1973. High-temperature versus conventional methods of drying southern pine lumber. Res. Pap. 73. Macon, GA: Georgia Forest Research Council. 29 p.
- Simpson, W.** 1991. Dry kiln operator's manual. Ag. Handb. 188. Madison, WI: U.S. Department of Agriculture, Forest Service, Forest Products Laboratory. 274 p.
- Wengert, E.** 1990. Drying oak lumber. Madison, WI: Department of Forestry, University of Wisconsin-Madison. 167 p.
- Youngs, R.** 1957. The perpendicular-to-grain mechanical properties of red oak as related to temperature, moisture content, and time. Res. Rep. 2079. Madison, WI: U.S. Department of Agriculture, Forest Service, Forest Products Laboratory. 111 p.